













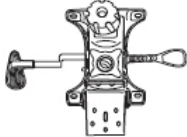

937016-937018

<p>1</p>  <p>1x</p>	<p>2</p>  <p>1x</p>	<p>3</p>  <p>1x</p>	<p>4</p>  <p>2x</p>
<p>5</p>  <p>5x</p>	<p>6</p>  <p>1x</p>	<p>7</p>  <p>1x</p>	<p>8</p>  <p>1x</p>
<p>A</p>  <p>6xM6x25</p>	<p>B</p>  <p>4xM6x14</p>	<p>C</p>  <p>3xM8x16</p>	<p>D</p>  <p>3xM8x22x1.2</p>
<p>E</p>  <p>10xM6x16x1.2</p>	<p>F</p>  <p>1xM5</p>	<p>G</p>  <p>1xM6</p>	<p>H</p>  <p>2xM6x25</p>



3

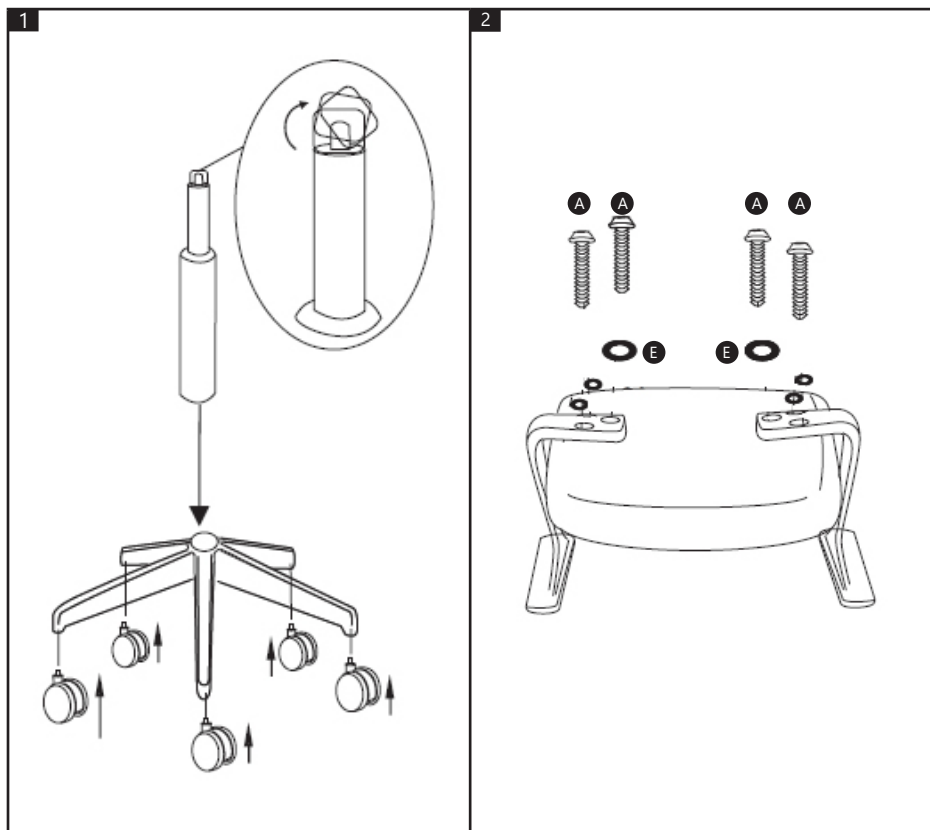
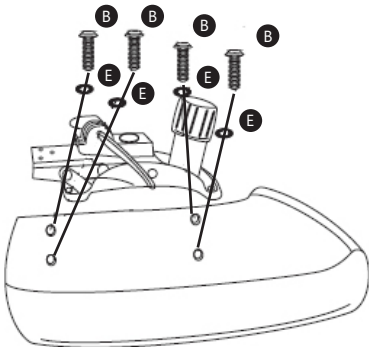

4

